



sedie
poltrone
pouf
tavolini bar
tavoli

**chairs design
contemporary**



Sedie



articolo **2035**
sedia struttura in metallo
imbottita in velluto panna.
*chair with metal structure
upholstered in cream velvet.*



articolo **2036**
sedia struttura in metallo
imbottita in velluto verde.
*chair with metal structure
upholstered in green velvet.*



articolo **2037**
sedia struttura in metallo
imbottita in velluto bordeaux.
*chair with metal structure
upholstered in burgundy velvet.*



articolo **2038**
sedia struttura in metallo
imbottita in velluto giallo ocra.
*chair with metal structure
upholstered in ochre yellow velvet.*

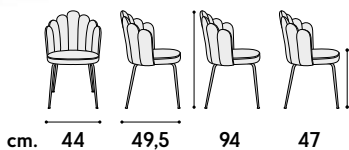

non impilabile. imballo 4 pz.
colli 1 - m³ cartone 0,33
*not stackable. packing 4 pcs.
packages 1 - m³ cardboard 0,33*



articolo **2006**
 sedia struttura in metallo
 imbottita in velluto bordeaux.
*chair with metal structure
 upholstered in burgundy velvet.*



articolo **2007**
 sedia struttura in metallo
 imbottita in velluto verde.
*chair with metal structure
 upholstered in green velvet.*



articolo **2008**
 sedia struttura in metallo
 imbottita in velluto blu.
*chair with metal structure
 upholstered in blue velvet.*

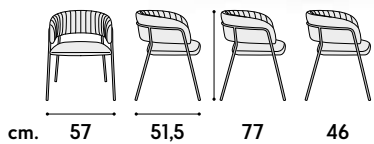

non impilabile. imballo 2 pz.
 colli 1 - m³ cartone 0,30
 not stackable. packing 2 pcs.
 packages 1 - m³ cardboard 0,30



articolo **2031**
sedia struttura in metallo
imbottita in velluto panna.
*chair with metal structure
upholstered in cream velvet.*



articolo **2032**
sedia struttura in metallo
imbottita in velluto tortora.
*chair with metal structure
upholstered in taupe velvet.*



articolo **2033**
sedia struttura in metallo
imbottita in velluto grigio.
*chair with metal structure
upholstered in gray velvet.*



articolo **2034**
sedia struttura in metallo
imbottita in velluto lilla.
*chair with metal structure
upholstered in lilac velvet.*

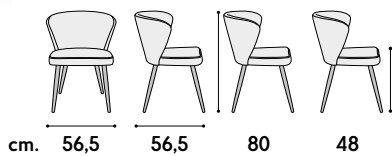

non impilabile. imballo 2 pz.
colli 1 - m³ cartone 0,17
*not stackable. packing 2 pcs.
packages 1 - m³ cardboard 0,17*



articolo **2073**
 sedia struttura in metallo
 imbottita in velluto beige.
*chair with metal structure
 upholstered in beige velvet.*

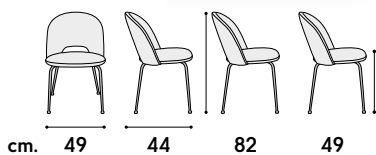

non impilabile. imballo 4 pz.
 colli 1 - m³ cartone 0,29
*not stackable. packing 4 pcs.
 packages 1 - m³ cardboard 0,29*



articolo **1926**
 sedia struttura in metallo
 imbottita in velluto grigio.
*chair with metal structure
 upholstered in gray velvet.*





articolo **1948**
 sedia struttura in metallo
 imbottita in velluto tortora.
*chair with metal structure
 upholstered in taupe velvet.*

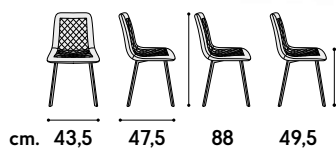

non impilabile. imballo 4 pz.
 colli 1 - m³ cartone 0,19
*not stackable. packing 4 pcs.
 packages 1 - m³ cardboard 0,19*

articolo **1949**
 sedia struttura in metallo
 imbottita in velluto grigio.
*chair with metal structure
 upholstered in gray velvet.*



articolo **1945**
 sedia struttura in metallo
 imbottita in velluto verde.
*chair with metal structure
 upholstered in green velvet.*



articolo **1950**
 sedia struttura in metallo
 imbottita in velluto rosa.
*chair with metal structure
 upholstered in pink velvet.*



articolo **1947**
 sedia struttura in metallo
 imbottita in velluto azzurro.
*chair with metal structure
 upholstered in sky blue velvet.*



articolo **2054**
sedia struttura in metallo
imbottita in velluto nero.
*chair with metal structure
upholstered in black velvet.*



articolo **1968**
sedia struttura in metallo
imbottita in velluto marrone.
*chair with metal structure
upholstered in brown velvet.*



articolo **1946**
sedia struttura in metallo
imbottita in velluto beige.
*chair with metal structure
upholstered in beige velvet.*





articolo **1959**
 sedia struttura in metallo
 imbottita in velluto beige.
*chair with metal structure
 upholstered in beige velvet.*

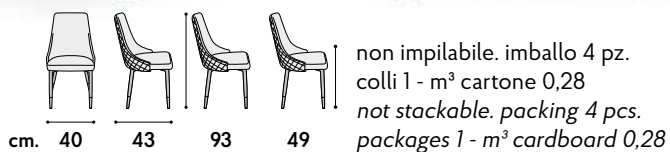

articolo **1961**
 sedia struttura in metallo
 imbottita in velluto grigio.
*chair with metal structure
 upholstered in gray velvet.*



articolo **1960**
 sedia struttura in metallo
 imbottita in velluto tortora.
*chair with metal structure
 upholstered in taupe velvet.*



articolo **1958**
 sedia struttura in metallo
 imbottita in velluto verde.
*chair with metal structure
 upholstered in green velvet.*



articolo **1914**
 sedia struttura in metallo
 imbottita in velluto grigio.
*chair with metal structure
 upholstered in gray velvet.*

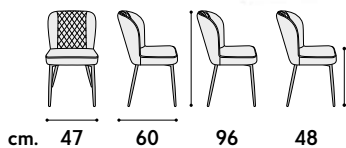

non impilabile. imballo 4 pz.
 colli 1 - m³ cartone 0,32
*not stackable. packing 4 pcs.
 packages 1 - m³ cardboard 0,32*

articolo **1941**
 sedia struttura in metallo
 imbottita in velluto rosa.
*chair with metal structure
 upholstered in pink velvet.*



articolo **1942**
 sedia struttura in metallo
 imbottita in velluto beige.
*chair with metal structure
 upholstered in beige velvet.*



articolo **1943**
 sedia struttura in metallo
 imbottita in velluto azzurro.
*chair with metal structure
 upholstered in sky blue velvet.*



articolo **1944**
 sedia struttura in metallo
 imbottita in velluto verde.
*chair with metal structure
 upholstered in green velvet.*



articolo **2019**
sedia con braccioli struttura
in metallo imbottita in tessuto grigio.
*chair with armrests structure
in metal upholstered in gray fabric.*



articolo **2020**
sedia con braccioli struttura
in metallo imbottita in tessuto nero.
*chair with armrests structure
in metal upholstered in black fabric.*

cm. 49 48 88 50

non impilabile. imballo 2 pz.
colli 2 - m³ cartone 0,25
not stackable. packing 2 pcs.
packages 2 - m³ cardboard 0,25



articolo **2021**
sedia struttura in metallo
imbottita in tessuto grigio.
*chair structure in metal
upholstered in gray fabric.*



articolo **2022**
sedia struttura in metallo
imbottita in tessuto nero.
*chair structure in metal
upholstered in black fabric.*

cm. 49 48 87 50

non impilabile. imballo 2 pz.
colli 2 - m³ cartone 0,29
*not stackable. packing 2 pcs.
packages 2 - m³ cardboard 0,29*



articolo **2023**
poltrona struttura in metallo
imbottita in tessuto grigio.
*armchair structure in metal
upholstered in gray fabric.*

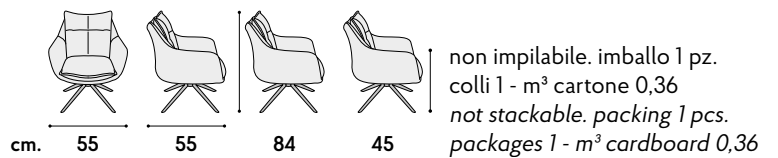



articolo **2024**
 poltrona struttura in metallo
 imbottita in tessuto nero.
*armchair structure in metal
 upholstered in black fabric.*



articolo **2009**
 set 2 pouf con vassoio struttura
 in MDF imbottito in tessuto grigio.
*set of 2 poufs with tray structure
 in MDF upholstered in gray fabric.*

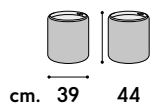

cm. 39 44

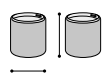

34,5 38

imballo 2 pz.
 colli 1 - m³ cartone 0,07
*packing 2 pcs. packages 1
 m³ cardboard 0,07*







articolo **2069**
 poltrona struttura in legno
 imbottita in tessuto verde.
*armchair with wooden structure
 upholstered in green fabric.*

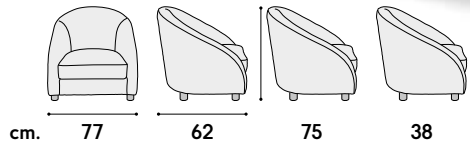

non impilabile. imballo 1 pz.
 colli 1 - m³ cartone 0,46
*not stackable. packing 1 pcs.
 packages 1 - m³ cardboard 0,46*

articolo **2071**
 pouf struttura in legno
 imbottito in velluto grigio e verde.
*pouf wooden structure upholstered
 in gray and green velvet.*



articolo **2070**
 poltrona struttura in legno
 imbottita in tessuto grigio.
*armchair with wooden structure
 upholstered in gray fabric.*

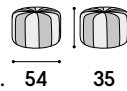

imballo 1 pz.
 colli 1 - m³ cartone 0,13
*packing 1 pcs. packages 1
 m³ cardboard 0,13*



articolo **2072**
 pouf struttura in legno
 imbottito in velluto rosso e blu.
*pouf wooden structure upholstered
 in red and blue velvet.*

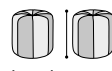

imballo 1 pz.
 colli 1 - m³ cartone 0,10
*packing 1 pcs. packages 1
 m³ cardboard 0,10*



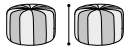

cm. 54 35

imballo 1 pz.
colli 1 - m³ cartone 0,13
packing 1 pcs. packages 1
m³ cardboard 0,13



articolo **2071**
pouf struttura in legno
imbottito in velluto grigio e verde.
*pouf wooden structure upholstered
in gray and green velvet.*

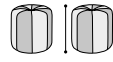

cm. 42 41

imballo 1 pz.
colli 1 - m³ cartone 0,10
packing 1 pcs. packages 1
m³ cardboard 0,10



articolo **2072**
pouf struttura in legno
imbottito in velluto rosso e blu.
*pouf wooden structure upholstered
in red and blue velvet.*



cm. 33,5 35,5

imballo 1 pz.
colli 1 - m³ cartone 0,04
packing 1 pcs. packages 1
m³ cardboard 0,04



articolo **2010**
pouf contenitore struttura
in MDF imbottito in velluto giallo.
*container pouf structure in MDF
upholstered in yellow velvet.*



articolo **2011**
pouf contenitore struttura
in MDF imbottito in velluto grigio.
*container pouf structure in MDF
upholstered in gray velvet.*



articolo **2012**
pouf contenitore struttura
in MDF imbottito in velluto verde.
*container pouf structure in MDF
upholstered in green velvet.*



articolo **2013**
pouf contenitore struttura
in MDF imbottito in velluto blu.
*container pouf structure in MDF
upholstered in blue velvet.*



cm. 36 44 31,5 38
 imballo 2 pz.
 colli 1 - m³ cartone 0,06
 packing 2 pcs. packages 1
 m³ cardboard 0,06



articolo **2014**
 set 2 pouf struttura in MDF
 imbottito in velluto bianco tortora.
 set of 2 poufs structure in MDF
 upholstered in white taupe velvet.

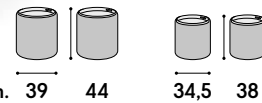

articolo **2009**
 set 2 pouf con vassoio struttura
 in MDF imbottito in tessuto grigio.
 set of 2 poufs with tray structure
 in MDF upholstered in gray fabric.

cm. 39 44 34,5 38
 imballo 2 pz.
 colli 1 - m³ cartone 0,07
 packing 2 pcs. packages 1
 m³ cardboard 0,07

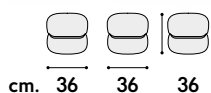

cm. 36 36 36
 imballo 1 pz.
 colli 1 - m³ cartone 0,05
 packing 1 pcs. packages 1
 m³ cardboard 0,05

articolo **2015**
 pouf struttura in MDF imbottito
 pelliccia di pecora nera.
 set of 2 poufs structure in MDF
 upholstered in black sheep fur.



cm. 44,5 35,5 36
 imballo 1 pz.
 colli 1 - m³ cartone 0,06
 packing 1 pcs. packages 1
 m³ cardboard 0,06

articolo **2017**
 pouf struttura in MDF imbottito
 pelliccia di pecora nera.
 set of 2 poufs structure in MDF
 upholstered in black sheep fur.

articolo **2016**
 pouf struttura in MDF imbottito
 pelliccia di pecora bianca.
 set of 2 poufs structure in MDF
 upholstered in white sheep fur.

articolo **2018**
 pouf struttura in MDF imbottito
 pelliccia di pecora bianca.
 set of 2 poufs structure in MDF
 upholstered in white sheep fur.



articolo **2046**
poltrona struttura in metallo
imbottita in velluto grigio chiaro.
*armchair with metal structure
upholstered in light gray velvet.*



articolo **2047**
poltrona struttura in metallo
imbottita in velluto rosa.
*armchair with metal structure
upholstered in pink velvet.*



articolo **2048**
poltrona struttura in metallo
imbottita in velluto verde.
*armchair with metal structure
upholstered in green velvet.*



articolo **2049**

poltrona struttura in metallo
imbottita in velluto grigio scuro.
*armchair with metal structure
upholstered in dark gray velvet.*

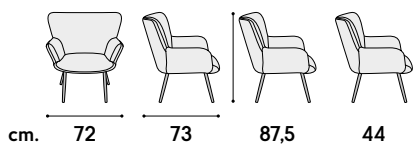

non impilabile. imballo 1 pz.
colli 1 - m³ cartone 0,30
*not stackable. packing 1 pcs.
packages 1 - m³ cardboard 0,30*

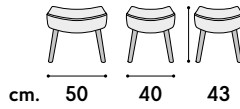

articolo **2029**
 poltrona e pouf struttura
 in metallo gambe in legno imbottita
 in tessuto patchwork. *armchair and pouf*
 metal structure legs in wood
 upholstered in patchwork fabric.

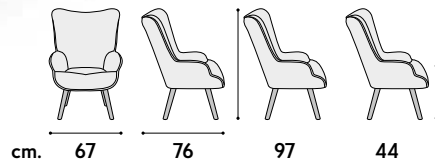

non impilabile. imballo 1 pz.
 colli 1 - m³ cartone 0,26
not stackable. packing 1 pcs.
 packages 1 - m³ cardboard 0,26



articolo **2030**
 poltrona struttura in metallo gambe
 in legno imbottita in tessuto patchwork.
armchair metal structure legs in wood
 upholstered in patchwork fabric.

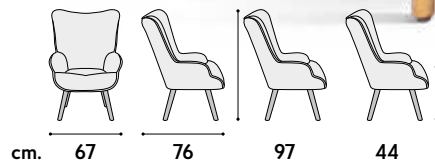

non impilabile. imballo 1 pz.
 colli 1 - m³ cartone 0,24
not stackable. packing 1 pcs.
 packages 1 - m³ cardboard 0,24



articolo **1923**

poltrona struttura in metallo
imbottita in velluto grigio.
*armchair with metal structure
upholstered in gray velvet.*

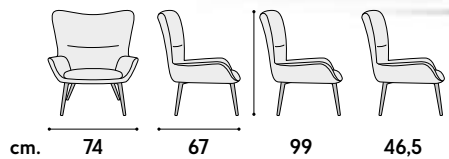

non impilabile. imballo 1 pz.
colli 1 - m³ cartone 0,22
*not stackable. packing 1 pcs.
packages 1 - m³ cardboard 0,22*



articolo **1924**

poltrona struttura in metallo
imbottita in velluto grigio.
*armchair with metal structure
upholstered in gray velvet.*

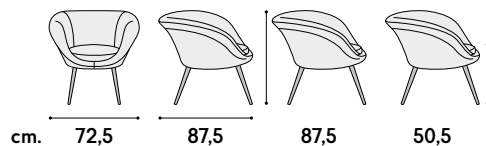

non impilabile. imballo 1 pz.
colli 1 - m³ cartone 0,28
*not stackable. packing 1 pcs.
packages 1 - m³ cardboard 0,28*



articolo **773**
 poltrona struttura in legno
 imbottita in tessuto patchwork.
*armchair with wooden structure
 upholstered in patchwork fabric.*

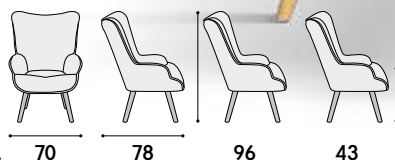

cm. 70 78 96 43
 non impilabile. imballo 1 pz.
 colli 1 - m³ cartone 0,46
*not stackable. packing 1 pcs.
 packages 1 - m³ cardboard 0,46*



articolo **769**
 poltrona struttura in legno
 imbottita in tessuto patchwork.
*armchair with wooden structure
 upholstered in patchwork fabric.*



articolo **774**
 poltrona struttura in legno
 e metallo imbottita in tessuto.
*armchair with wooden and metal
 structure upholstered in fabric.*

cm. l. 62 p. 84 h. 84 h.s. 47
 non impilabile. imballo 1 pz.
 colli 1 - m³ cartone 0,47
*not stackable. packing 1 pcs.
 packages 1 - m³ cardboard 0,47*



articolo **785**
 poltrona struttura in legno
 imbottita in tessuto patchwork.
*armchair with wooden structure
 upholstered in patchwork fabric.*

cm. l. 56 p. 66 h. 94 h.s. 49
 non impilabile. imballo 2 pz.
 colli 1 - m³ cartone 0,30
*not stackable. packing 2 pcs.
 packages 1 - m³ cardboard 0,30*



articolo 653

poltrona struttura in legno
imbottita in tessuto patchwork.
*armchair with wooden structure
upholstered in patchwork fabric.*

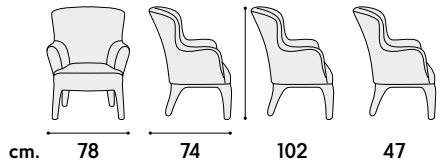

non impilabile. imballo 1 pz.
colli 1 - m³ cartone 0,49
*not stackable. packing 1 pcs.
packages 1 - m³ cardboard 0,49*



articolo 918

sedia struttura in legno e metallo
imbottita in tessuto patchwork.
*chair wooden and metal structure
upholstered in patchwork fabric.*

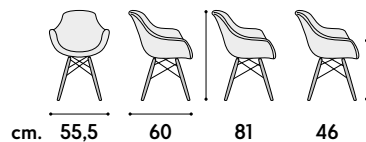

non impilabile. imballo 2 pz.
colli 1 - m³ cartone 0,27
*not stackable. packing 2 pcs.
packages 1 - m³ cardboard 0,27*



articolo **1925**
 poltrona struttura in metallo
 imbottita in velluto grigio.
*armchair with metal structure
 upholstered in gray velvet.*

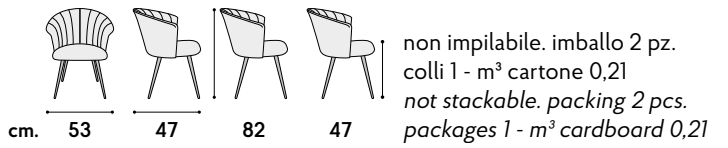

articolo **1915**
 sedia struttura in metallo
 imbottita in velluto grigio.
*chair with metal structure
 upholstered in gray velvet.*

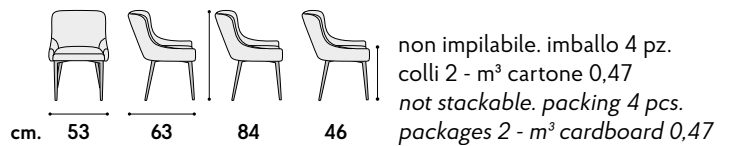



articolo 1755
sedia struttura in metallo
imbottita in ecopelle grigia.
*chair with metal frame
upholstered in gray eco-leather.*

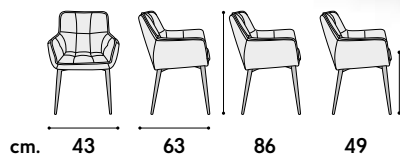

non impilabile. imballo 2 pz.
colli 1 - m³ cartone 0,24
*not stackable. packing 2 pcs.
packages 1 - m³ cardboard 0,24*



articolo **03**
sedia struttura in metallo
imbottita in ecopelle marrone.
*chair with metal frame upholstered
in brown eco-leather.*



articolo **04**
sedia struttura in metallo
imbottita in ecopelle antracite.
*chair with metal frame upholstered
in anthracite eco-leather.*

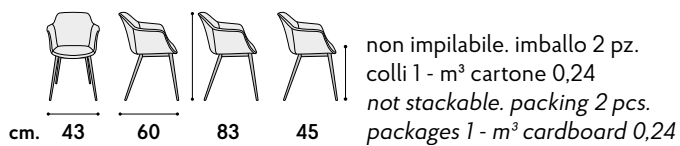



articolo **06**
 sedia struttura in metallo
 imbottita in ecopelle marrone.
*chair metal frame upholstered
 in brown eco-leather.*

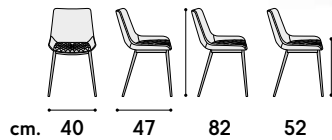

non impilabile. imballo 2 pz.
 colli 1 - m³ cartone 0,20
*not stackable. packing 2 pcs.
 packages 1 - m³ cardboard 0,20*



articolo **07**
 sedia struttura in metallo
 imbottita in ecopelle antracite.
*chair metal frame upholstered
 in anthracite eco-leather.*

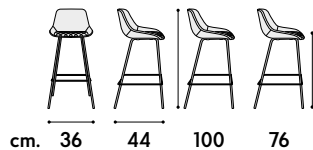

non impilabile. imballo 2 pz.
 colli 1 - m³ cartone 0,22
*not stackable. packing 2 pcs.
 packages 1 - m³ cardboard 0,22*



articolo **10**
 sgabello struttura in metallo
 imbottito in ecopelle antracite.
*Stool with metal frame upholstered
 in anthracite eco-leather.*



articolo **709**
 sedia struttura in metallo
 imbottita in ecopelle bianca.
*chair with metal structure
 upholstered in white eco-leather.*



articolo **710**
 sedia struttura in metallo
 imbottita in ecopelle tortora.
*chair with metal structure
 upholstered in taupe eco-leather.*



articolo **711**
 sedia struttura in metallo
 imbottita in ecopelle nera.
*chair with metal structure
 upholstered in black eco-leather.*



articolo **712**
 sedia struttura in metallo
 imbottita in ecopelle grigia.
*chair with metal structure
 upholstered in gray eco-leather.*



articolo **713**
 sedia struttura in metallo
 imbottita in ecopelle antracite.
*chair with metal structure
 upholstered in anthracite eco-leather.*

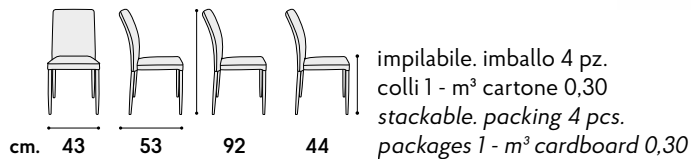



articolo **921**
 sedia struttura in metallo
 imbottita in ecopelle tortora.
*chair with metal structure
 upholstered taupe eco-leather.*



articolo **922**
 sedia struttura in metallo
 imbottita in ecopelle grigia.
*chair with metal structure
 upholstered gray eco-leather.*



cm. l. 43 p. 59,5 h. 99,5 h.s. 46
 non impilabile. imballo 2 pz.
 colli 1 - m³ cartone 0,21
*not stackable. packing 2 pcs.
 packages 1 - m³ cardboard 0,21*

articolo **923**
 sedia struttura in metallo
 imbottita in ecopelle ghiaccio.
*chair with metal structure
 upholstered ice eco-leather.*



articolo **977**
 sedia struttura in metallo
 imbottita in ecopelle bianca.
*chair with metal structure
 upholstered white eco-leather.*



articolo **978**
 sedia struttura in metallo
 imbottita in ecopelle tortora.
*chair with metal structure
 upholstered taupe eco-leather.*



cm. l. 44 p. 41 h. 91 h.s. 47
 impilabile. imballo 4 pz.
 colli 1 - m³ cartone 0,32
*stackable. packing 4 pcs.
 packages 1 - m³ cardboard 0,32*

articolo **979**
 sedia struttura in metallo
 imbottita in ecopelle grigia.
*chair with metal structure
 upholstered gray eco-leather.*



articolo **952**
 sedia struttura in metallo
 imbottita in ecopelle bianca.
*chair with metal structure
 upholstered white eco-leather.*



articolo **953**
 sedia struttura in metallo
 imbottita in ecopelle tortora.
*chair with metal structure
 upholstered taupe eco-leather.*



cm. l. 44 p. 56 h. 94,5 h.s. 46
 non impilabile. imballo 4 pz.
 colli 2 - m³ cartone 0,32
*not stackable. packing 4 pcs.
 packages 2 - m³ cardboard 0,32*

articolo **954**
 sedia struttura in metallo
 imbottita in ecopelle grigia.
*chair with metal structure
 upholstered gray eco-leather.*



articolo **982**
 sedia struttura in metallo
 imbottita in ecopelle grigio.
cm. l. 45 p. 42 h. 95 h.s. 48
 non impilabile. imballo 4 pz.
 colli 2 - m³ cartone 0,34



articolo **980**
 sedia struttura in metallo
 imbottita in ecopelle bianco.
cm. l. 45 p. 42 h. 95 h.s. 48
 non impilabile. imballo 4 pz.
 colli 2 - m³ cartone 0,34



articolo **981**
 sedia struttura in metallo
 imbottita in ecopelle tortora.
cm. l. 45 p. 42 h. 95 h.s. 48
 non impilabile. imballo 4 pz.
 colli 2 - m³ cartone 0,34



articolo **983**
 sedia struttura in metallo
 imbottita in ecopelle nero.
cm. l. 45 p. 42 h. 95 h.s. 48
 non impilabile. imballo 4 pz.
 colli 2 - m³ cartone 0,34



articolo **928**
 sedia struttura in metallo
 imbottita in ecopelle crema.
cm. l. 43 p. 55 h. 86 h.s. 47
 non impilabile. imballo 4 pz.
 colli 1 - m³ cartone 0,20



articolo **927**
 sedia struttura in metallo
 imbottita in ecopelle grigia.
cm. l. 43 p. 55 h. 86 h.s. 47
 non impilabile. imballo 4 pz.
 colli 1 - m³ cartone 0,20



articolo **926**
 sedia struttura in metallo
 imbottita in ecopelle beige.
cm. l. 43 p. 55 h. 86 h.s. 47
 non impilabile. imballo 4 pz.
 colli 1 - m³ cartone 0,20



articolo **622**
 sedia struttura in metallo
 imbottita in ecopelle bianca.
cm. l. 44 p. 53 h. 90 h.s. 46
 impilabile. imballo 6 pz.
 colli 1 - m³ cartone 0,38



articolo **612**
 sedia struttura in metallo
 imbottita in ecopelle nero.
cm. l. 42 p. 49 h. 88 h.s. 46
 non impilabile. imballo 6 pz.
 colli 1 - m³ cartone 0,36



articolo **613**
 sedia struttura in metallo
 imbottita in ecopelle bianco.
cm. l. 42 p. 49 h. 88 h.s. 46
 non impilabile. imballo 6 pz.
 colli 1 - m³ cartone 0,36



articolo **696**
 sedia struttura in metallo
 imbottita in ecopelle antracite.
cm. l. 51,5 p. 43 h. 94,5 h.s. 46
 non impilabile. imballo 6 pz.
 colli 1 - m³ cartone 0,34



articolo **697**
 sedia struttura in metallo
 imbottita in ecopelle beige.
cm. l. 51,5 p. 43 h. 94,5 h.s. 46
 non impilabile. imballo 6 pz.
 colli 1 - m³ cartone 0,34



articolo **702**
sedia struttura in metallo
imbottita in tessuto beige.
*chair with metal structure
upholstered in beige fabric.*



articolo **700**
sedia struttura in metallo
imbottita in tessuto grigio.
*chair with metal structure
upholstered in gray fabric.*



cm. l. 46 p. 46 h. 88 h.s. 40,5
non impilabile. imballo 4 pz.
colli 2 - m³ cartone 0,40
*not stackable. packing 4 pcs.
packages 2 - m³ cardboard 0,40*

articolo **701**
sedia struttura in metallo
imbottita in tessuto nero.
*chair with metal structure
upholstered in black fabric.*



articolo **698**
sedia struttura in metallo
imbottita in tessuto beige.
*chair with metal structure
upholstered in beige fabric.*



articolo **904**
sedia struttura in metallo
imbottita in tessuto grigio.
*chair with metal structure
upholstered in gray fabric.*



cm. l. 48 p. 44 h. 87,5 h.s. 40,5
non impilabile. imballo 4 pz.
colli 2 - m³ cartone 0,54
*not stackable. packing 4 pcs.
packages 2 - m³ cardboard 0,54*

articolo **699**
sedia struttura in metallo
imbottita in tessuto nero.
*chair with metal structure
upholstered in black fabric.*



articolo **905**
sedia struttura in legno e metallo
sedile in polipropilene bianco.
*chair with wooden and metal
structure seat in white polypropylene.*
cm. l. 54 p. 46 h. 80 h.s. 49
non impilabile. imballo 6 pz.
colli 2 - m³ cartone 0,34



articolo **906**
sedia struttura in legno e metallo
sedile in polipropilene verde avocado.
*chair with wooden and metal structure
seat in avocado green polypropylene.*
cm. l. 54 p. 46 h. 80 h.s. 49
non impilabile. imballo 6 pz.
colli 2 - m³ cartone 0,34



articolo **907**
sedia struttura in legno e metallo
sedile in polipropilene grigio caldo.
*chair with wooden and metal structure
seat in avocado warm gray polypropylene.*
cm. l. 54 p. 46 h. 80 h.s. 49
non impilabile. imballo 6 pz.
colli 2 - m³ cartone 0,34



articolo **707**
sedia struttura in legno e metallo
sedile in polipropilene grigio.
*chair with wooden and metal
structure seat in gray polypropylene.*
cm. l. 59 p. 58 h. 85 h.s. 45
non impilabile. imballo 4 pz.
colli 1 - m³ cartone 0,19



articolo **951**
sedia a dondolo struttura in legno e metallo
sedile in polipropilene bianco con cuscino in
ecopelle bianco. *rocking chair wooden structure
and metal seat in white polypropylene
with white eco-leather cushion.*
cm. l. 59 p. 69 h. 81,5 h.s. 48
non impilabile. imballo 2 pz.
colli 1 - m³ cartone 0,15



articolo **777**
sedia struttura in metallo con sedile
in polipropilene bianco. *chair metal structure
with white polypropylene seat.*
cm. l. 52 p. 50 h. 83 h.s. 47
non impilabile. imballo 4 pz.
colli 1 - m³ cartone 0,18



articolo **726**

sedia struttura in legno e metallo sedile in polipropilene con cuscino in ecopelle bianca.
chair with wooden and metal structure, polypropylene seat with white eco-leather cushion.

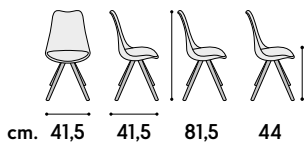

non impilabile. imballo 4 pz.
 colli 1 - m³ cartone 0,18
*not stackable. packing 4 pcs.
 packages 1 - m³ cardboard 0,18*



articolo **993**

sedia struttura in legno e metallo sedile in polipropilene con cuscino in ecopelle grigia.
chair with wooden and metal structure, polypropylene seat with gray eco-leather cushion.



articolo **764**

sedia struttura in legno e metallo sedile in polipropilene con cuscino in ecopelle bianca.
chair with wooden and metal structure, polypropylene seat with white eco-leather cushion.
 imballo 2 pz. packing 2 pcs.

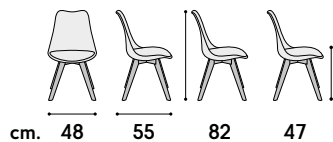

non impilabile.
 colli 1 - m³ cartone 0,13
*not stackable.
 packages 1 - m³ cardboard 0,13*



articolo **975**

sedia struttura in legno e metallo sedile in polipropilene con cuscino in ecopelle grigia.
chair with wooden and metal structure, polypropylene seat with gray eco-leather cushion.
 imballo 6 pz. packing 6 pcs.



articolo **955**
 sedia struttura in metallo
 imbottita in ecopelle bianca.
*chair with metal structure
 upholstered white eco-leather.*



articolo **957**
 sedia struttura in metallo
 imbottita in ecopelle nera.
*chair with metal structure
 upholstered black eco-leather.*



cm. l. 45 p. 50 h. 99 h.s. 47
 non impilabile. imballo 4 pz.
 colli 1 - m³ cartone 0,24
*not stackable. packing 4 pcs.
 packages 1 - m³ cardboard 0,24*

articolo **958**
 sedia struttura in metallo
 imbottita in ecopelle grigia.
*chair with metal structure
 upholstered gray eco-leather.*



articolo **930**
 sedia struttura in metallo
 imbottita in ecopelle grigia.
 cm. l. 51 p. 41 h. 98 h.s. 46
 non impilabile. imballo 6 pz.
 colli 1 - m³ cartone 0,34



articolo **931**
 sedia struttura in metallo
 imbottita in ecopelle tortora.
 cm. l. 51 p. 41 h. 98 h.s. 46
 non impilabile. imballo 6 pz.
 colli 1 - m³ cartone 0,34



articolo **932**
 sedia struttura in metallo
 imbottita in ecopelle bianca.
 cm. l. 51 p. 41 h. 98 h.s. 46
 non impilabile. imballo 6 pz.
 colli 1 - m³ cartone 0,34.



articolo **933**
 sedia struttura in metallo
 imbottita in ecopelle nera.
 cm. l. 51 p. 41 h. 98 h.s. 46
 non impilabile. imballo 6 pz.
 colli 1 - m³ cartone 0,34



articolo **610**
sedia struttura in metallo con
sedile imbottito in ecopelle bianco.
cm. l. 39 p. 48 h. 89 h.s. 48
non impilabile. imballo 6 pz.
colli 1 - m³ cartone 0,26



articolo **704**
sedia struttura metallo
con sedile in polipropilene nero.
*chair with metal structure
with black polypropylene seat.*



articolo **705**
sedia struttura metallo
con sedile in polipropilene grigio.
*chair with metal structure
with gray polypropylene seat.*

cm. l. 50 p. 55 h. 83 h.s. 45
non impilabile. imballo 4 pz.
colli 1 - m³ cartone 0,18
*not stackable. packing 4 pcs.
packages 1 - m³ cardboard 0,18*



articolo **663**
sedia struttura in metallo
imbottita in ecopelle bianco.
*chair with metal structure
upholstered white eco-leather.*



articolo **665**
sedia struttura in metallo
imbottita in ecopelle beige.
*chair with metal structure
upholstered beige eco-leather.*



cm. l. 51 p. 44 h. 91 h.s. 49
non impilabile. imballo 4 pz.
colli 1 - m³ cartone 0,32
*not stackable. packing 4 pcs.
packages 1 - m³ cardboard 0,32*

articolo **784**
sedia struttura in metallo
imbottita in ecopelle antracite.
*chair with metal structure
upholstered anthracite eco-leather.*



articolo 576
 sedia struttura legno colore wengè
 imbottita in ecopelle wengè.
*chair structure wengè wood color
 upholstered in wengè eco-leather.*



articolo 577
 sedia struttura legno colore bianco
 imbottita in ecopelle bianca.
*chair structure white wood color
 upholstered in white eco-leather.*



articolo 578
 sedia struttura legno colore tortora
 imbottita in ecopelle tortora.
*chair structure taupe wood color
 upholstered in taupe eco-leather.*



articolo 1921
 sedia struttura legno colore antracite
 imbottita in ecopelle antracite.
*chair structure anthracite wood color
 upholstered in anthracite eco-leather.*



articolo 615
 sedia struttura legno colore ciliegio
 imbottita in ecopelle bianca.
*chair structure cherry wood color
 upholstered in white eco-leather.*



articolo 687
 sedia struttura legno colore ghiaccio
 imbottita in ecopelle ghiaccio.
*chair structure ice wood color
 upholstered in ice eco-leather.*



articolo 902
 sedia struttura in legno colore beige
 imbottita in ecopelle beige.
*chair structure beige wood color
 upholstered in beige eco-leather.*



articolo 1922
 sedia struttura legno colore tortora
 scuro imbottita in ecopelle tortora
 scuro.
*chair structure dark taupe wood color
 upholstered in dark taupe eco-leather.*



articolo **677**
 sedia struttura in legno colore
 tortora imbottita in ecopelle tortora
 con bottoni. *chair structure in taupe*
wood color upholstered in taupe
eco-leather with buttons.



articolo **675**
 sedia struttura in legno colore
 ghiaccio imbottita in ecopelle ghiaccio
 con bottoni. *chair structure in ice*
wood color upholstered in ice
eco-leather with buttons.



articolo **676**
 sedia struttura in legno colore
 wengè imbottita in ecopelle wengè
 con bottoni. *chair structure in wengè*
wood color upholstered in wengè
eco-leather with buttons.



articolo **678**
 sedia struttura in legno colore
 bianco imbottita in ecopelle bianco
 con bottoni. *chair structure in white*
wood color upholstered in white
eco-leather with buttons.



articolo **901**
 sedia struttura in legno colore
 beige imbottita in ecopelle beige
 con bottoni. *chair structure in beige*
wood color upholstered in beige
eco-leather with buttons.

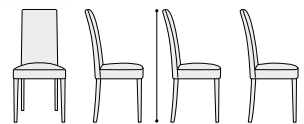

cm. 40 40 101 46

non impilabile. imballo 2 pz.
 colli 1 - m³ cartone 0,32
 not stackable. packing 2 pcs.
 packages 1 - m³ cardboard 0,32





articolo **908**
 sedia in polipropilene
 colore bianco. *polypropylene*
 chair white color.

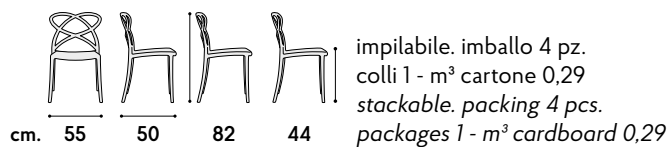

articolo **909**
 sedia in polipropilene
 colore avocado. *polypropylene*
 chair avocado color.

articolo **910**
 sedia in polipropilene
 colore grigio caldo. *polypropylene*
 chair warm gray color.



articolo **911**
sedia in polipropilene
colore bianco. *polypropylene*
chair white color.

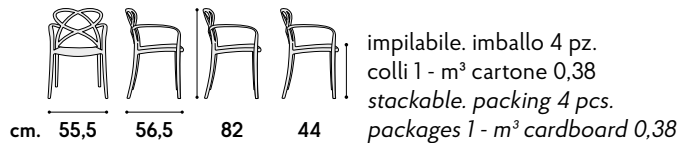

articolo **912**
sedia in polipropilene
colore avocado. *polypropylene*
chair avocado color.



articolo **913**
sedia in polipropilene
colore grigio caldo. *polypropylene*
chair warm gray color.



articolo **960**
sgabello in polipropilene
colore grigio caldo. *polypropylene
stool warm gray color.*



cm. 41 46 102 76

impilabile. imballo 4 pz.
colli 1 - m³ cartone 0,36
*stackable. packing 4 pcs.
packages 1 - m³ cardboard 0,36*



articolo **961**
sgabello in polipropilene
colore nero. *polypropylene
stool black color.*



articolo **959**
sgabello in polipropilene
colore bianco. *polypropylene
stool white color.*





articolo **2081**
sedia in polipropilene
colore nero.
*polypropylene chair
black colour.*



articolo **2082**
sedia in polipropilene
colore grigio.
*polypropylene chair
gray color.*



articolo **2083**
sedia in polipropilene
colore tortora.
*polypropylene chair
taupe color.*

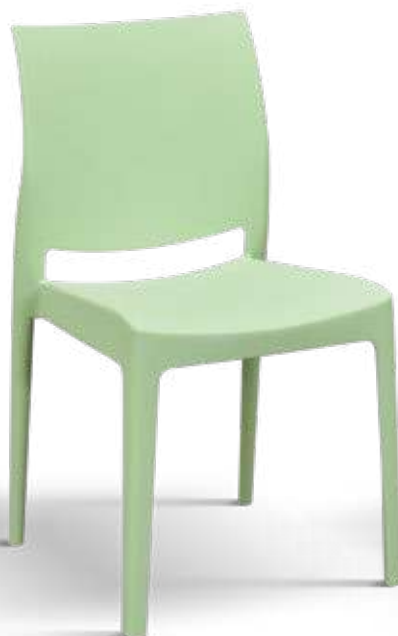

articolo **2025**
sedia in polipropilene
colore verde pastello.
*polypropylene chair
pastel green color.*



articolo **2026**
sedia in polipropilene
colore giallo mostarda.
*polypropylene chair
mustard yellow colour.*



articolo **2027**
sedia in polipropilene
colore verde.
*polypropylene chair
green color.*



articolo **2080**
sedia in polipropilene
colore bianco.
*polypropylene chair
white color.*



articolo **2028**
sedia in polipropilene
colore blu pastello.
*polypropylene chair
pastel blue color.*

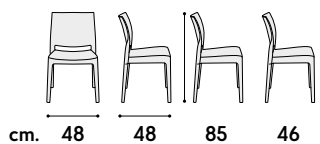

impilabile. imballo 4 pz.
colli 1 - m³ cartone 0,22
*stackable. packing 4 pcs.
packages 1 - m³ cardboard 0,22*



articolo **1993**
sedia in polipropilene
colore nero. *polypropylene*
chair black color.



articolo **1994**
sedia in polipropilene
colore bianco. *polypropylene*
chair white color.



articolo **1995**
sedia in polipropilene
colore tortora. *polypropylene*
chair taupe color.



articolo **1996**
sedia in polipropilene
colore grigio. *polypropylene*
chair gray color.

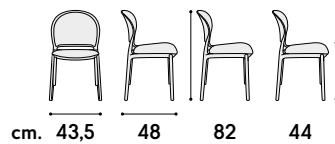

impilabile. imballo 4 pz.
colli 1 - m³ cartone 0,30
stackable. packing 4 pcs.
packages 1 - m³ cardboard 0,30



articolo **2045**
 sedia in polipropilene
 trasparente. *transparent*
polypropylene chair.

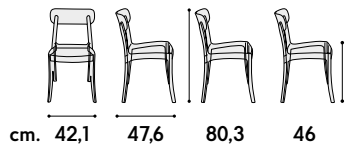

impilabile. imballo 4 pz.
 colli 1 - m³ cartone 0,30
stackable. packing 4 pcs.
packages 1 - m³ cardboard 0,30



articolo **695**
 sedia in polipropilene
 trasparente. *transparent*
polypropylene chair.

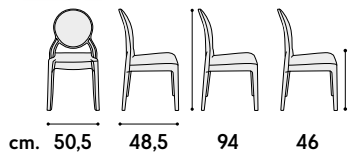

impilabile. imballo 4 pz.
 colli 1 - m³ cartone 0,30
stackable. packing 4 pcs.
packages 1 - m³ cardboard 0,30



articolo **1951**
sedia in polipropilene
colore giallo. *polypropylene*
chair yellow color.



articolo **1952**
sedia in polipropilene
colore bianco. *polypropylene*
chair white color.



articolo **1953**
sedia in polipropilene
colore grigio. *polypropylene*
chair gray color.



articolo **1954**
sedia in polipropilene
colore tortora. *polypropylene*
chair taupe color.



articolo **1955**
 sedia in polipropilene
 colore nero. *polypropylene*
 chair black color.



articolo **1956**
 sedia in polipropilene
 colore rosa. *polypropylene*
 chair pink color.

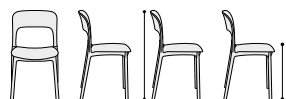

 cm. 40 40 79 45,5
 impilabile. imballo 4 pz.
 colli 1 - m³ cartone 0,24
 stackable. packing 4 pcs.
 packages 1 - m³ cardboard 0,24



articolo **2039**
sedia in polipropilene
colore tortora.
*polypropylene chair
taupe color.*



articolo **2040**
sedia in polipropilene
colore grigio.
*polypropylene chair
gray color.*



articolo **2041**
sedia in polipropilene
colore sabbia.
*polypropylene chair
sand colour.*



articolo **2042**
sedia in polipropilene
colore arancione.
*polypropylene chair
orange color.*



articolo **2043**
sedia in polipropilene
colore nero.
*polypropylene chair
black color.*



articolo **2044**
sedia in polipropilene
colore verde.
*polypropylene chair
green color.*

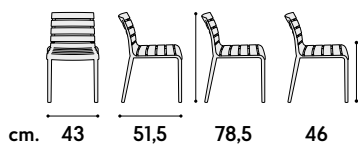

cm. 43 51,5 78,5 46

impilabile. imballo 6 pz.
colli 1 - m³ cartone 0,34
stackable. packing 6 pcs.
packages 1 - m³ cardboard 0,34



articolo **1962**
sedia in polipropilene
colore verde. *polypropylene
chair green color.*



articolo **1963**
sedia in polipropilene
colore bianco. *polypropylene
chair white color.*



articolo **1964**
sedia in polipropilene
colore nero. *polypropylene
chair black color.*



articolo **1965**
sedia in polipropilene
colore blu. *polypropylene
chair blue color.*



articolo **1966**
sedia in polipropilene
colore grigio. *polypropylene
chair gray color.*



articolo **1967**
sedia in polipropilene
colore giallo. *polypropylene
chair yellow color.*

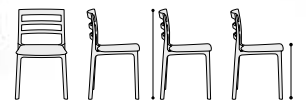

cm. 45 45 80 45
impilabile. imballo 4 pz.
colli 1 - m³ cartone 0,28
*stackable. packing 4 pcs.
packages 1 - m³ cardboard 0,28*



articolo **1894**
sedia in polipropilene
colore bianco. *polypropylene*
chair white color.



articolo **1895**
sedia in polipropilene
colore nero. *polypropylene*
chair black color.



articolo **1842**
sedia in polipropilene
colore tortora. *polypropylene*
chair taupe color.



articolo **1841**
sedia in polipropilene
colore grigio. *polypropylene*
chair gray color.

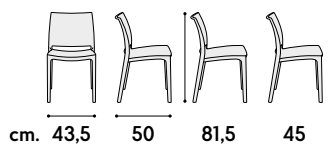

impilabile. imballo 1 pz.
colli 1 - m³ cartone 0,05
stackable. packing 1 pcs.
packages 1 - m³ cardboard 0,05



articolo **2055**
 sedia in polipropilene schienale
 traforato colore bianco.
*polypropylene chair perforated
 backrest white color.*



articolo **2056**
 sedia in polipropilene schienale
 traforato colore nero.
*polypropylene chair perforated
 backrest black color.*



articolo **2057**
 sedia in polipropilene schienale
 traforato colore grigio.
*polypropylene chair perforated
 backrest gray color.*



articolo **2058**
 sedia in polipropilene schienale
 traforato colore tortora.
*polypropylene chair perforated
 backrest taupe color.*

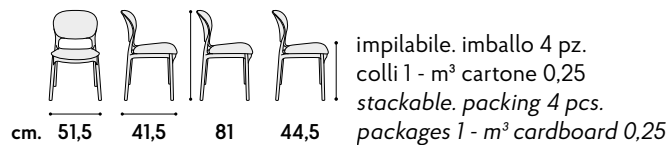



articolo **2050**
sedia in polipropilene colore
verde chiaro. *polypropylene chair
light green color.*



articolo **2051**
sedia in polipropilene colore bianco.
polypropylene chair white color.



articolo **2052**
sedia in polipropilene colore nero.
polypropylene chair black color.



articolo **2053**
sedia in polipropilene colore grigio.
polypropylene chair gray color.

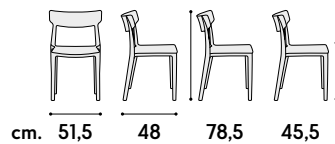

impilabile. imballo 1 pz.
colli 1 - m³ cartone 0,19
*stackable. packing 1 pcs.
packages 1 - m³ cardboard 0,19*



articolo **990**
 sedia struttura in metallo e seduta
 in polipropilene colore bianco.
*chair with metal structure and seat
 in white color polypropylene.*



articolo **991**
 sedia struttura in metallo e seduta
 in polipropilene colore grigio.
*chair with metal structure and seat
 in gray color polypropylene.*



articolo **992**
 sedia struttura in metallo e seduta
 in polipropilene colore tortora.
*chair with metal structure and seat
 in taupe color polypropylene.*



articolo **2068**
 sedia struttura in metallo e seduta
 in polipropilene colore arancione.
*chair with metal structure and seat
 in orange color polypropylene.*

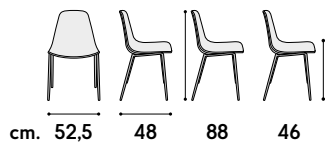

non impilabile. imballo 4 pz.
 colli 1 - m³ cartone 0,16
*not stackable. packing 4 pcs.
 packages 1 - m³ cardboard 0,16*



articolo **2076**
 sedia pieghevole struttura
 in metallo e seduta in polipropilene
 colore tortora. *chair with metal
 structure and seat in taupe
 color polypropylene.*



articolo **2077**
 sedia pieghevole struttura
 in metallo e seduta in polipropilene
 colore bianco. *chair with metal
 structure and seat in white
 color polypropylene.*



articolo **2078**
 sedia pieghevole struttura
 in metallo e seduta in polipropilene
 colore nero. *chair with metal
 structure and seat in black
 color polypropylene.*



articolo **2079**
 sedia pieghevole struttura
 in metallo e seduta in polipropilene
 colore verde. *chair with metal
 structure and seat in green
 color polypropylene.*

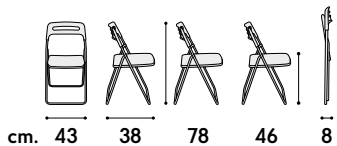

non impilabile. imballo 6 pz.
 colli 1 - m³ cartone 0,10
 not stackable. packing 6 pcs.
 packages 1 - m³ cardboard 0,10



articolo **987**
 sedia in polipropilene
 colore bianco. *polypropylene*
 chair white color.



articolo **988**
 sedia in polipropilene
 colore grigio. *polypropylene*
 chair gray color.



articolo **989**
 sedia in polipropilene
 colore tortora. *polypropylene*
 chair taupe color.



cm. 54 46 84 46
 non impilabile. imballo 4 pz.
 colli 1 - m³ cartone 0,16
 not stackable. packing 4 pcs.
 packages 1 - m³ cardboard 0,16



articolo **969**
 sedia in polipropilene
 colore bianco. *polypropylene*
 chair white color.



articolo **970**
 sedia in polipropilene
 colore grigio. *polypropylene*
 chair gray color.



articolo **971**
 sedia in polipropilene
 colore tortora. *polypropylene*
 chair taupe color.



cm. 50 43 81 46
 impilabile. imballo 4 pz.
 colli 1 - m³ cartone 0,24
 stackable. packing 4 pcs.
 packages 1 - m³ cardboard 0,24



articolo **972**
sedia in polipropilene
colore bianco. *polypropylene*
chair white color.



articolo **973**
sedia in polipropilene
colore grigio. *polypropylene*
chair gray color.



articolo **974**
sedia in polipropilene
colore nero. *polypropylene*
chair black color.

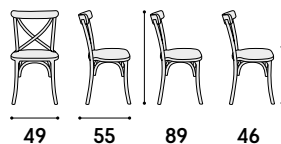

non impilabile. imballo 2 pz.
colli 1 - m³ cartone 0,31
not stackable. packing 2 pcs.
packages 1 - m³ cardboard 0,31



articolo **914**
 sedia struttura in legno naturale
 e seduta in rattan.
*chair with structure in natural
 wood and rattan seat.*



articolo **780**
 sedia struttura in legno bianco
 consumato e seduta in rattan.
*chair with worn white wooden
 structure and rattan seat.*



articolo **781**
 sedia struttura in legno nero
 consumato e seduta in rattan.
*chair with worn black wooden
 structure and rattan seat.*

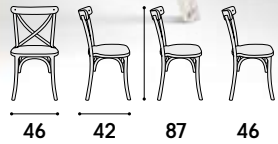

non impilabile. imballo 1 pz.
 colli 1 - m³ cartone 0,09
*not stackable. packing 1 pcs.
 packages 1 - m³ cardboard 0,09*



articolo **1905**
 sedia struttura e seduta
 in legno naturale.
*chair with structure and
 seat in natural wood.*



articolo **1904**
 sedia struttura e seduta
 in legno bianco consumato.
*chair with structure and seat
 in worn white wood.*



articolo **915**
 sedia struttura e seduta
 in legno verde consumato.
*chair structure and seat
 in worn green wood.*

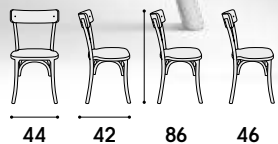

non impilabile. imballo 1 pz.
 colli 1 - m³ cartone 0,08
*not stackable. packing 1 pcs.
 packages 1 - m³ cardboard 0,08*



cm. l. 43 p. 79 h. 76 h.s. 41,5
impilabile. imballo 4 pz.
colli 1 - m³ cartone 0,30
stackable. packing 4 pcs.
packages 1 - m³ cardboard 0,30



articolo 903
sedia struttura in legno
e seduta in massello colore bianco.
chair with wooden structure and
seat in solid white colour.



articolo 1753
sedia struttura in legno con
sedile imbottito in tessuto grigio.
cm. l. 51 p. 55,5 h. 89 h.s. 45
non impilabile. imballo 2 pz.
colli 1 - m³ cartone 0,09



cm. l. 42,5 p. 37,5 h. 90 h.s. 44
non impilabile. imballo 2 pz.
colli 1 - m³ cartone 0,24
not stackable. packing 2 pcs.
packages 1 - m³ cardboard 0,24



articolo 641
sedia struttura in legno colore
tortora e seduta imbottita in tessuto.
chair with wooden structure taupe
color and upholstered seat in fabric.



articolo 681
sedia struttura in legno colore
bianco e seduta imbottita in tessuto.
chair with wooden structure white
color and upholstered seat in fabric.

articolo 964
sedia struttura in legno con
sedile imbottito in tessuto grigio.
cm. l. 49,5 p. 46 h. 79 h.s. 47
non impilabile. imballo 2 pz.
colli 1 - m³ cartone 0,06



articolo **590**
sedia struttura faggio e seduta
in paglia. *chair with beech tree
structure and seat straw*



articolo **591**
sedia struttura faggio e seduta
in massello. *chair with beech tree
structure and seat solid wood.*



articolo **592**
sedia struttura faggio e seduta
in massello. *chair with beech tree
structure and seat solid wood.*



articolo **760**
sedia struttura faggio e seduta
in massello. *chair with beech tree
structure and seat solid wood.*



articolo **761**
sedia struttura faggio e seduta
in paglia. *chair with beech tree
structure and seat straw.*



articolo **588**
sedia struttura faggio e seduta
in massello. *chair with beech tree
structure and seat solid wood.*



articolo **593**
sedia struttura faggio e seduta
in paglia. *chair with beech tree
structure and seat straw.*



articolo **594**
sedia struttura faggio e seduta
in massello. *chair with beech tree
structure and seat solid wood.*



articolo **595**
sedia struttura faggio e seduta
in paglia. *chair with beech tree
structure and seat straw.*



articolo **589**
sedia struttura faggio e seduta
in paglia. *chair with beech tree
structure and seat straw.*



articolo **486**
sedia struttura faggio e seduta
in massello finitura Bassano.
*chair with beech tree structure
and seat solid wood Bassano finish.*



articolo **2119**
sedia struttura faggio finitura
naturale e seduta in paglia.
*chair with beech tree structure
natural finish and seat straw.*



articolo **1001**
sedia laccata bianco struttura
faggio e seduta in massello.
*white lacquered chair with beech
tree structure and seat solid wood.*



articolo **1007**
sedia sedia laccata bianco
struttura faggio e seduta in paglia.
*white lacquered chair with beech
tree structure and seat straw.*



articolo **751**
sedia laccata bianco struttura
faggio e seduta in massello.
*white lacquered chair with beech
tree structure and seat solid wood.*



articolo **714**
sedia sedia laccata bianco
struttura faggio e seduta in paglia.
*white lacquered chair with beech
tree structure and seat straw.*



articolo **1002**
sedia laccata bianco struttura
faggio e seduta in massello.
*white lacquered chair with beech
tree structure and seat solid wood.*



articolo **1022**
sedia sedia laccata bianco
struttura faggio e seduta in paglia.
*white lacquered chair with beech
tree structure and seat straw.*



articolo **782**
sedia in metallo colore bianco.
metal chair white color.
cm. l. 51,5 p. 44,5 h. 85 h.s. 46
impilabile. imballo 4 pz.
colli 1 - m³ cartone 0,30



articolo **783**
sedia in metallo colore grigio.
metal chair gray color.
cm. l. 51,5 p. 44,5 h. 85 h.s. 46
impilabile. imballo 4 pz.
colli 1 - m³ cartone 0,30



articolo **995**
sedia struttura in metallo
imbottita in ecopelle grigia.
cm. l. 42,5 p. 36 h. 97,5 h.s. 45,5
non impilabile. imballo 6 pz.
colli 1 - m³ cartone 0,34



articolo **934**
sgabello in metallo
colore acciaio.
metal stool steel color.



articolo **935**
sgabello in metallo colore
canna di fucile.
metal stool gunmetal color.



cm. l. 43 p. 43 h. 76
impilabile. imballo 6 pz.
colli 1 - m³ cartone 0,30
stackable. packing 6 pcs.
packages 1 - m³ cardboard 0,30

articolo **937**
sgabello in metallo colore
bianco invecchiato.
metal stool aged white color.



articolo **2104**

tavolo base in metallo colore bianco
 piano nobilitato finitura bianco anticato.
*base table in white metal white
 melamine antique white finish top.*

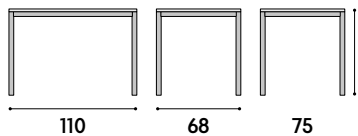

colli 2 - m³ cartone 0,20
 packages 2 m³ cardboard 0,20



articolo **2103** piano nobilitato
 finitura grigio cemento. *melamine
 cement grayfinish top.*



articolo **2102** piano nobilitato
 finitura rovere rustico. *melamine
 rustic oak wood finish top.*

TAVOLI AUTOLIVELLANTI



48 48 85 46

impilabile. imballo 4 pz.
colli 1 - m³ cartone 0,22
stackable. packing 4 pcs.
packages 1 - m³ cardboard 0,22



articolo **1892**
tavolo autolivellante finitura grigio
antracite. *self-leveling table*
anthracite gray finish.

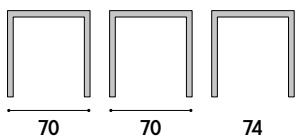

70 70 74
impilabile. colli 1 - m³ cartone 0,36
stackable. packages 1 m³ cardboard 0,36

articolo **1893**
tavolo autolivellante finitura grigio
antracite. *self-leveling table*
anthracite gray finish.

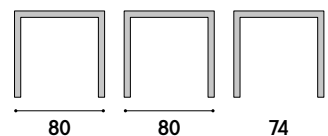

80 80 74
impilabile. colli 1 - m³ cartone 0,47
stackable. packages 1 m³ cardboard 0,47

articolo **2098**
 piano nobilitato finitura bianco
 anticato. *melamine antique*
white finish top.

articolo **914**
 sedia struttura in legno naturale
 e seduta in rattan.
chair with structure in natural
wood and rattan seat.

articolo **2097**
 piano nobilitato finitura grigio
 cemento. *melamine cement*
grayfinish top.



non impilabile. imballo 1 pz.
 colli 1 - m³ cartone 0,09
not stackable. packing 1 pcs.
packages 1 - m³ cardboard 0,09



articolo **2096**
 tavolo struttura legno piano
 nobilitato finitura rovere rustico.
table wood structure melamine
rustic oak wood finish top.

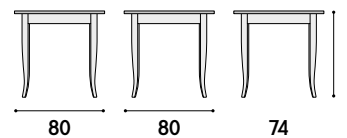

colli 2 - m³ cartone 0,13
packages 2 m³ cardboard 0,13



articolo **2068**

sedia struttura in metallo e seduta in polipropilene colore arancione.
chair with metal structure and seat in orange color polypropylene.



52,5 48 88 46

non impilabile. imballo 4 pz.
colli 1 - m³ cartone 0,16
*not stackable. packing 4 pcs.
packages 1 - m³ cardboard 0,16*

articolo **2103**

tavolo base in metallo colore bianco piano nobilitato finitura grigio cemento.
base table in white metal melamine cement gray finish top.

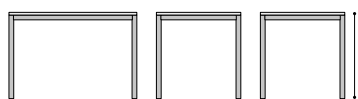

110 68 75

colli 2 - m³ cartone 0,20
packages 2 m³ cardboard 0,20

articolo **2083**

sedia in polipropilene colore tortora.
polypropylene chair taupe color.

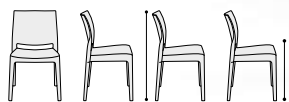

cm. 48 48 85 46

impilabile. imballo 4 pz.
colli 1 - m³ cartone 0,22
*stackable. packing 4 pcs.
packages 1 - m³ cardboard 0,22*

articolo **2099**

tavolo base in metallo grigio antracite piano nobilitato finitura rovere rustico.
base table in anthracite gray metal melamine rustic oak wood finish top.

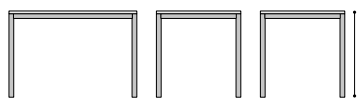

110 68 75

colli 2 - m³ cartone 0,20
packages 2 m³ cardboard 0,20



articolo **2102** piano nobilitato finitura rovere rustico. *melamine rustic oak wood finish top.*



articolo **2104** piano nobilitato finitura bianco anticato. *melamine antique white finish top.*



articolo **2100** piano nobilitato finitura grigio cemento. *melamine cement gray finish top.*



articolo **2101** piano nobilitato finitura bianco anticato. *melamine antique white finish top.*



articolo **2038**

sedia struttura in metallo
imbottita in velluto giallo ocra.
*chair with metal structure
upholstered in ochre yellow velvet.*

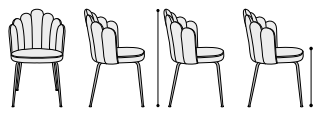

44 49,5 94 47

non impilabile. imballo 4 pz.
colli 1 - m³ cartone 0,33
*not stackable. packing 4 pcs.
packages 1 - m³ cardboard 0,33*



articolo **2102** piano nobilitato
finitura rovere rustico. *melamine
rustic oak wood finish top.*



articolo **2103** piano nobilitato
finitura grigio cemento. *melamine
cement gray finish top.*

articolo **2104**

tavolo base in metallo colore
bianco piano nobilitato finitura
bianco anticato. *base table
in white metal color melamine
antique white finish top.*

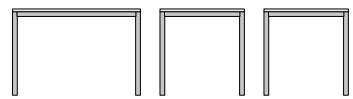

110 68 75

colli 2 - m³ cartone 0,20
packages 2 m³ cardboard 0,20



articolo **1963**
 sedia in polipropilene
 colore bianco. *polypropylene*
chair white color.

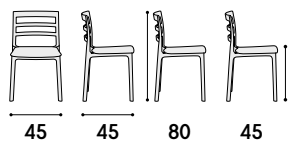

impilabile. imballo 4 pz.
 colli 1 - m³ cartone 0,28
stackable. packing 4 pcs.
packages 1 - m³ cardboard 0,28



articolo **2106** piano nobilitato
 finitura grigio cemento. *melamine*
cement grayfinish top.

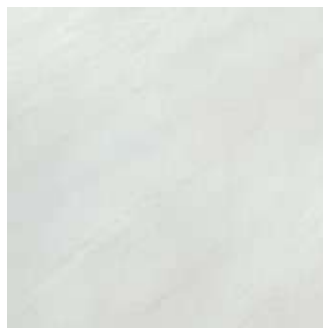

articolo **2107** piano nobilitato
 finitura bianco anticato. *melamine*
antique white finish top.

articolo **2105**
 tavolo base in metallo grigio
 antracite piano nobilitato finitura
 rovere rustico. *base table in*
anthracite gray metal melamine
rustic oak wood finish top.

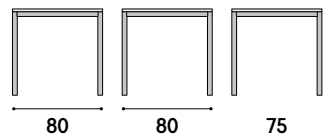

colli 2 - m³ cartone 0,17
packages 2 m³ cardboard 0,17



articolo **2108**
 tavolo base in metallo colore
 bianco piano nobilitato finitura
 rovere rustico. *base table*
in white metal white melamine
rustic oak wood finish top.

articolo **2109**
 tavolo base in metallo colore bianco
 piano nobilitato finitura grigio
 cemento. *base table in white metal*
melamine cement grayfinish top.

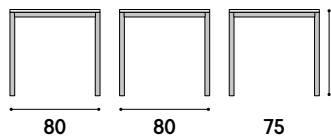

colli 2 - m³ cartone 0,17
packages 2 m³ cardboard 0,17

articolo **2045**
 sedia in polipropilene trasparente.
transparent polypropylene chair.



impilabile. imballo 4 pz.
 colli 1 - m³ cartone 0,30
stackable. packing 4 pcs.
packages 1 - m³ cardboard 0,30



articolo **2108** piano nobilitato
 finitura rovere rustico. *melamine*
rustic oak wood finish top.



articolo **2110** piano nobilitato
 finitura bianco anticato. *melamine*
antique white finish top.





SO 2.5
ATO 2.5
CINO 3
3.5
4
5
POURED COFFEE 5
3.5



articolo **1996**
 sedia in polipropilene
 colore grigio. *polypropylene*
chair gray color.

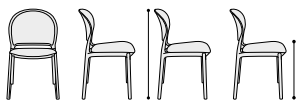

43,5 48 82 44
 impilabile. imballo 4 pz.
 colli 1 - m³ cartone 0,30
stackable. packing 4 pcs.
packages 1 - m³ cardboard 0,30

articolo **1688**
 base in metallo grigio antracite.
base in anthracite gray metal.
 cm. l. 50 p. 50 h. 72
 peso kg. 14 cadauno
 m³ totale colli: 0,03

articolo **1744**
 piano laminato finitura rovere nodato.
laminated top with knotted oak finish.
 cm. l. 80 p. 80 sp. 18
 m³ totale colli: 0,03

BASI IN METALLO CON PIEDINI REGOLABILI. imballo 4 pz. colli 2
METAL BASES WITH ADJUSTABLE FEET. packing 4 pcs. packages 2

base in metallo GRIGIO ANTRACITE.
ANTHRACITE GRAY metal base.



articolo **1688**
cm. l. 50 p. 50 h. 72
peso kg. 14 cadauno
m³ totale colli: 0,03

articolo **1689**
cm. l. 50 p. 50 h. 105
peso kg. 15 cadauno
m³ totale colli: 0,04

base in metallo colore BIANCO.
WHITE color metal base.



articolo **1690**
cm. l. 50 p. 50 h. 72
peso kg. 14 cadauno
m³ totale colli: 0,03

articolo **1691**
cm. l. 50 p. 50 h. 105
peso kg. 15 cadauno
m³ totale colli: 0,04

base in metallo colore BRONZO.
BRONZE color metal base.



articolo **1692**
cm. l. 50 p. 50 h. 72
peso kg. 14 cadauno
m³ totale colli: 0,03

articolo **1693**
cm. l. 50 p. 50 h. 105
peso kg. 15 cadauno
m³ totale colli: 0,04

base in metallo GRIGIO ANTRACITE.
ANTHRACITE GRAY metal base.



articolo **1694**
cm. ø. 50 h. 72
peso kg. 14 cadauno
m³ totale colli: 0,03

articolo **1695**
cm. ø. 50 h. 105
peso kg. 15 cadauno
m³ totale colli: 0,04

base in metallo colore BIANCO.
WHITE color metal base.



articolo **1696**
cm. ø. 50 h. 72
peso kg. 14 cadauno
m³ totale colli: 0,03

articolo **1697**
cm. ø. 50 h. 105
peso kg. 15 cadauno
m³ totale colli: 0,04

base in metallo colore BRONZO.
BRONZE color metal base.



articolo **1698**
cm. ø. 50 h. 72
peso kg. 14 cadauno
m³ totale colli: 0,03

articolo **1699**
cm. ø. 50 h. 105
peso kg. 15 cadauno
m³ totale colli: 0,04

PIANI IN LAMINATO sp. 18 mm. imballo 2 pz. colli n. 1
THICK LAMINATE TOPS 18 mm. packing 2 pcs. packages n. 1

piano finitura CEMENTO.
CEMENT finish top.



articolo **1730**
cm. ø. 60 sp. 18 m³ totale colli: 0,02
articolo **1731**
cm. ø. 70 sp. 18 m³ totale colli: 0,03
articolo **1732**
cm. ø. 80 sp. 18 m³ totale colli: 0,03

piano finitura ROVERE NODATO.
KNOTTED OAK WOOD finish top.



articolo **1733**
cm. ø. 60 sp. 18 m³ totale colli: 0,02
articolo **1734**
cm. ø. 70 sp. 18 m³ totale colli: 0,03
articolo **1735**
cm. ø. 80 sp. 18 m³ totale colli: 0,03

piano finitura BIANCO CONSUMATO.
CONSUMED WHITE finish top.



articolo **1736**
cm. ø. 60 sp. 18 m³ totale colli: 0,02
articolo **1737**
cm. ø. 70 sp. 18 m³ totale colli: 0,03
articolo **1738**
cm. ø. 80 sp. 18 m³ totale colli: 0,03

piano finitura CEMENTO.
CEMENT finish top.



articolo **1739**
cm. l. 60 p. 60 sp. 18 m³ totale colli: 0,02
articolo **1740**
cm. l. 70 p. 70 sp. 18 m³ totale colli: 0,03
articolo **1741**
cm. l. 80 p. 80 sp. 18 m³ totale colli: 0,03

piano finitura ROVERE NODATO.
KNOTTED OAK WOOD finish top.



articolo **1742**
cm. l. 60 p. 60 sp. 18 m³ totale colli: 0,02
articolo **1743**
cm. l. 70 p. 70 sp. 18 m³ totale colli: 0,03
articolo **1744**
cm. l. 80 p. 80 sp. 18 m³ totale colli: 0,03

piano finitura BIANCO CONSUMATO.
CONSUMED WHITE finish top.



articolo **1745**
cm. l. 60 p. 60 sp. 18 m³ totale colli: 0,02
articolo **1746**
cm. l. 70 p. 70 sp. 18 m³ totale colli: 0,03
articolo **1747**
cm. l. 80 p. 80 sp. 18 m³ totale colli: 0,03



BASI IN METALLO CON PIEDINI REGOLABILI. imballo 4 pz. colli 2
METAL BASES WITH ADJUSTABLE FEET. packing 4 pcs. packages 2



PIANI IN HPL sp. 10 mm. imballo 2 pz. colli n. 1
HPL TOPS thick. 10 mm. packing 2 pcs. packages n. 1

piano finitura CEMENTO.
CEMENT finish top.



articolo **1700**
 cm. ø. 60 sp. 10 m³ totale colli: 0,02
 articolo **1701**
 cm. ø. 70 sp. 10 m³ totale colli: 0,03
 articolo **1702**
 cm. ø. 80 sp. 10 m³ totale colli: 0,03

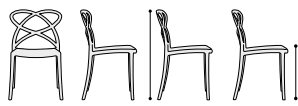

cm. 55 50 82 44
 impilabile. imballo 4 pz.
 colli 1 - m³ cartone 0,29
 stackable. packing 4 pcs.
 packages 1 - m³ cardboard 0,29

articolo **908**
 sedia in polipropilene
 colore bianco. polypropylene
 chair white color.

piano finitura CEMENTO.
CEMENT finish top.



articolo **1715**
 cm. l. 60 p. 60 sp. 10 m³ totale colli: 0,02
 articolo **1716**
 cm. l. 70 p. 70 sp. 10 m³ totale colli: 0,03
 articolo **1717**
 cm. l. 80 p. 80 sp. 10 m³ totale colli: 0,03



cm. 55 50 82 44
 impilabile. imballo 4 pz.
 colli 1 - m³ cartone 0,29
 stackable. packing 4 pcs.
 packages 1 - m³ cardboard 0,29

articolo **909**
 sedia in polipropilene
 colore avocado. polypropylene
 chair avocado color.

piano finitura PIOMBO.
LEAD finish top.



articolo **1703**
 cm. ø. 60 sp. 10 m³ totale colli: 0,02
 articolo **1704**
 cm. ø. 70 sp. 10 m³ totale colli: 0,03
 articolo **1705**
 cm. ø. 80 sp. 10 m³ totale colli: 0,03

piano finitura ROVERE NODATO.
KNOTTED OAK WOOD finish top.



articolo **1709**
 cm. ø. 60 sp. 10 m³ totale colli: 0,02
 articolo **1710**
 cm. ø. 70 sp. 10 m³ totale colli: 0,03
 articolo **1711**
 cm. ø. 80 sp. 10 m³ totale colli: 0,03

piano finitura PIOMBO.
LEAD finish top.



articolo **1718**
 cm. l. 60 p. 60 sp. 10 m³ totale colli: 0,02
 articolo **1719**
 cm. l. 70 p. 70 sp. 10 m³ totale colli: 0,03
 articolo **1720**
 cm. l. 80 p. 80 sp. 10 m³ totale colli: 0,03

piano finitura ROVERE NODATO.
KNOTTED OAK WOOD finish top.



articolo **1724**
 cm. l. 60 p. 60 sp. 10 m³ totale colli: 0,02
 articolo **1725**
 cm. l. 70 p. 70 sp. 10 m³ totale colli: 0,03
 articolo **1726**
 cm. l. 80 p. 80 sp. 10 m³ totale colli: 0,03

piano finitura BRONZO.
BRONZE finish top.



articolo **1706**
 cm. ø. 60 sp. 10 m³ totale colli: 0,02
 articolo **1707**
 cm. ø. 70 sp. 10 m³ totale colli: 0,03
 articolo **1708**
 cm. ø. 80 sp. 10 m³ totale colli: 0,03

piano finitura BIANCO.
WHITE finish top.



articolo **1712**
 cm. ø. 60 sp. 10 m³ totale colli: 0,02
 articolo **1713**
 cm. ø. 70 sp. 10 m³ totale colli: 0,03
 articolo **1714**
 cm. ø. 80 sp. 10 m³ totale colli: 0,03

piano finitura BRONZO.
BRONZE finish top.



articolo **1721**
 cm. l. 60 p. 60 sp. 10 m³ totale colli: 0,02
 articolo **1722**
 cm. l. 70 p. 70 sp. 10 m³ totale colli: 0,03
 articolo **1723**
 cm. l. 80 p. 80 sp. 10 m³ totale colli: 0,03

piano finitura BIANCO.
WHITE finish top.



articolo **1727**
 cm. l. 60 p. 60 sp. 10 m³ totale colli: 0,02
 articolo **1728**
 cm. l. 70 p. 70 sp. 10 m³ totale colli: 0,03
 articolo **1729**
 cm. l. 80 p. 80 sp. 10 m³ totale colli: 0,03



piano nobilitato finitura olmo perla.
melamine pearl elm wood finish top.

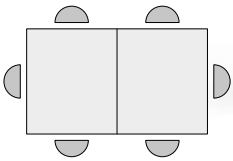

160

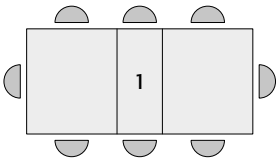

200

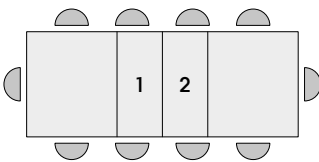

240

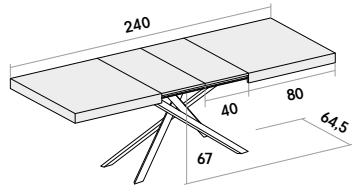
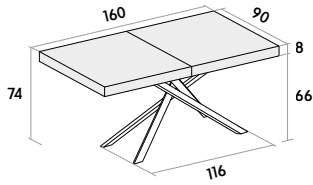

piano nobilitato grigio cemento.
melamine cement gray finish top.



piano nobilitato finitura bianco frassinato.
melamine white ash wood finish top.



colli 3 - m³ cartone 0,42 packages 3 m³ cardboard 0,42

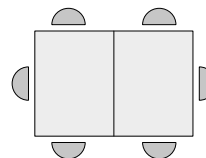

140

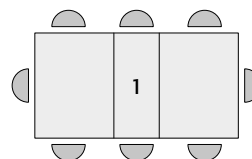

180

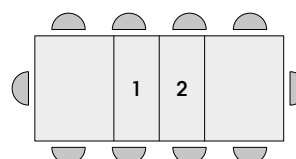

220

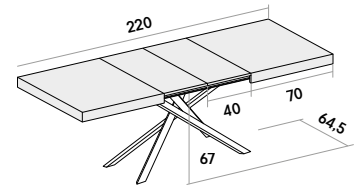
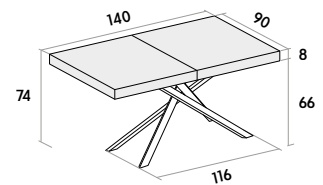

colli 3 - m³ cartone 0,42 packages 3 m³ cardboard 0,42



base in metallo colore nero piano nobilitato
finitura rovere rustico con 2 allunghe interne da 40 cm.
articolo **1929** tavolo. *table*. cm. l. 140/180/220 p. 90 h. 74
articolo **1930** tavolo. *table*. cm. l. 160/200/240 p. 90 h. 74



base in metallo colore bianco piano nobilitato
finitura rovere rustico con 2 allunghe interne da 40 cm.
articolo **2112** tavolo. *table*. cm. l. 140/180/220 p. 90 h. 74
articolo **2116** tavolo. *table*. cm. l. 160/200/240 p. 90 h. 74



base in metallo colore nero piano nobilitato
finitura olmo perla con 2 allunghe interne da 40 cm.
articolo **1937** tavolo. *table*. cm. l. 140/180/220 p. 90 h. 74
articolo **1936** tavolo. *table*. cm. l. 160/200/240 p. 90 h. 74



base in metallo colore bianco piano nobilitato
finitura olmo perla con 2 allunghe interne da 40 cm.
articolo **2113** tavolo. *table*. cm. l. 140/180/220 p. 90 h. 74
articolo **2117** tavolo. *table*. cm. l. 160/200/240 p. 90 h. 74



base in metallo colore nero piano nobilitato
finitura grigio cemento con 2 allunghe interne da 40 cm.
articolo **1933** tavolo. *table*. cm. l. 140/180/220 p. 90 h. 74
articolo **1932** tavolo. *table*. cm. l. 160/200/240 p. 90 h. 74



base in metallo colore bianco piano nobilitato
finitura grigio cemento con 2 allunghe interne da 40 cm.
articolo **2111** tavolo. *table*. cm. l. 140/180/220 p. 90 h. 74
articolo **2115** tavolo. *table*. cm. l. 160/200/240 p. 90 h. 74



base in metallo colore nero piano nobilitato
finitura bianco frassinato con 2 allunghe interne da 40 cm.
articolo **1977** tavolo. *table*. cm. l. 140/180/220 p. 90 h. 74
articolo **1976** tavolo. *table*. cm. l. 160/200/240 p. 90 h. 74



base in metallo colore bianco piano nobilitato
finitura bianco frassinato con 2 allunghe interne da 40 cm.
articolo **2114** tavolo. *table*. cm. l. 140/180/220 p. 90 h. 74
articolo **2118** tavolo. *table*. cm. l. 160/200/240 p. 90 h. 74



articolo 1991

tavolo struttura laccato bianco piano in nobilitato finitura rovere rustico con 2 allunghe da cm. 40. *table white lacquered structure melamine top rustic oak wood finish with 2 extensions of cm. 40.* cm. l 140/220 p. 90 h. 77



articolo 1871

tavolo struttura e piano in nobilitato finitura rovere rustico con 2 allunghe da cm. 40. *table with structure and top in melamine rustic oak wood finish with 2 extensions of cm. 40.* cm. l 140/220 p. 90 h. 77



articolo 1873

tavolo struttura e piano in nobilitato finitura olmo perla con 2 allunghe da cm. 40. *table with structure and top in melamine in pearl elm wood finish with 2 extensions of cm. 40.* cm. l 140/220 p. 90 h. 77



articolo 1869

tavolo struttura e piano in nobilitato finitura grigio cemento con 2 allunghe da cm. 40. *table with structure and top in melamine in cement gray finish with 2 extensions of cm. 40.* cm. l 140/220 p. 90 h. 77



articolo 1973

tavolo struttura e piano in nobilitato finitura bianco frassinato con 2 allunghe da cm. 40. *table with structure and top in melamine in white ash wood finish with 2 extensions of cm. 40.* cm. l 140/220 p. 90 h. 77

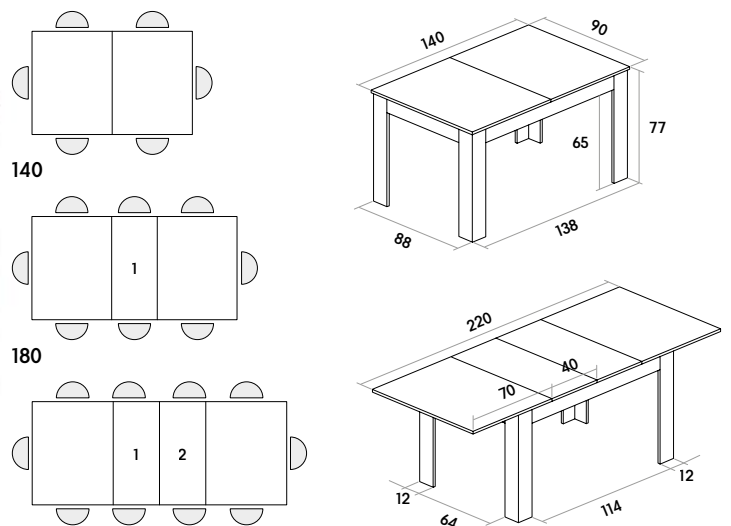

220

colli 2 - m³ cartone 0,24 packages 2 m³ cardboard 0,24



articolo **1990**
 tavolo struttura laccato bianco piano in nobilitato finitura rovere rustico con 1 allunga da cm. 50. *table white lacquered structure melamine top rustic oak wood finish with 1 extension of cm. 50.*
 cm. l 120/170 p. 90 h. 77



articolo **1870**
 tavolo struttura e piano in nobilitato finitura rovere rustico con 1 allunga da cm. 50. *table with structure and top in melamine rustic oak wood finish with 1 extension of cm. 50.*
 cm. l 120/170 p. 90 h. 77



articolo **1872**
 tavolo struttura e piano in nobilitato finitura olmo perla con 1 allunga da cm. 50. *table with structure and top in melamine in pearl elm wood finish with 1 extension of cm. 50.*
 cm. l 120/170 p. 90 h. 77



articolo **1868**
 tavolo struttura e piano in nobilitato finitura grigio cemento con 1 allunga da cm. 50. *table with structure and top in melamine in cement gray finish with 1 extension of cm. 50.*
 cm. l 120/170 p. 90 h. 77



articolo **1972**
 tavolo struttura e piano in nobilitato finitura bianco frassinato con 1 allunga da cm. 50. *table with structure and top in melamine in white ash wood finish with 1 extension of cm. 50.*
 cm. l 120/170 p. 90 h. 77

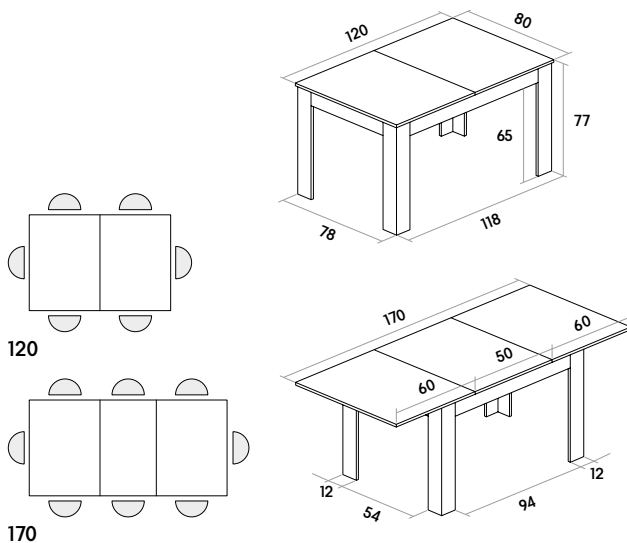

colli 2 - m³ cartone 0,18 packages 2 m³ cardboard 0,18



articolo **1992**
 tavolo struttura laccato bianco piano in nobilitato
 finitura rovere rustico. *table white lacquered structure*
top in melamine rustic oak wood finish.
 cm. l 90/180 p. 90 h. 79/77



articolo **1900**
 tavolo struttura e piano in nobilitato
 finitura rovere rustico. *table with structure and top*
in in melamine rustic oak wood finish.
 cm. l 90/180 p. 90 h. 79/77



articolo **1903**
 tavolo struttura e piano in nobilitato
 finitura olmo perla. *table with structure and top*
in melamine in pearl elm wood finish.
 cm. l 90/180 p. 90 h. 79/77



articolo **1901**
 tavolo struttura e piano in nobilitato
 finitura grigio cemento. *table with structure*
and top in melamine cement gray finish.
 cm. l 90/180 p. 90 h. 79/77



articolo **1975**
 tavolo struttura e piano in nobilitato
 finitura bianco frassinato. *table with structure and top*
in melamine in white ash wood finish.
 cm. l 90/180 p. 90 h. 79/77

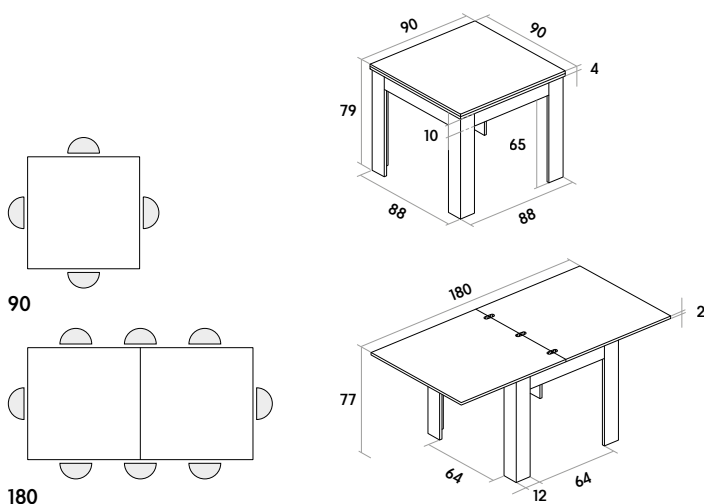

colli 2 - m³ cartone 0,20 packages 2 m³ cardboard 0,20

articolo **1955**
 sedia in polipropilene
 colore nero. *polypropylene*
chair black color.



40 40 79 45,5

impilabile. imballo 4 pz.
 colli 1 - m³ cartone 0,24
stackable. packing 4 pcs.
packages 1 - m³ cardboard 0,24



articolo **1987**
 tavolo struttura in metallo colore
 nero piano finitura rovere rustico.
table with black metal structure
rustic oak wood finish top.

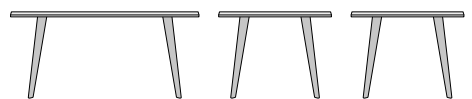

160 90 76

colli 2 - m³ cartone 0,14 *packages 2 m³ cardboard 0,14*

Articolo	Descrizione	Pagina
03	sedia	24
04	sedia	24
06	sedia	25
07	sedia	25
10	sgabello	25
486	sedia	59
576	sedia	34
577	sedia	34
578	sedia	34
588	sedia	58
589	sedia	59
590	sedia	58
591	sedia	58
592	sedia	58
593	sedia	58
594	sedia	58
595	sedia	58
610	sedia	33
612	sedia	28
613	sedia	28
615	sedia	34
622	sedia	28
641	sedia	57
653	poltrona	21
663	sedia	33
665	sedia	33
675	sedia	35
676	sedia	35
677	sedia	35
678	sedia	35
681	sedia	57
687	sedia	34
695	sedia	43
696	sedia	28
697	sedia	28
698	sedia	29
699	sedia	29
700	sedia	29
701	sedia	29
702	sedia	29
704	sedia	33
705	sedia	33
707	sedia	30
709	sedia	26
710	sedia	26
711	sedia	26
712	sedia	26
713	sedia	26
714	sedia	59
726	sedia	31
751	sedia	59
760	sedia	58
761	sedia	58
764	sedia	31
769	poltrona	20
773	poltrona	20
774	poltrona	20
777	sedia	30
780	sedia	56

Articolo	Descrizione	Pagina
781	sedia	56
782	sedia	60
783	sedia	60
784	sedia	33
785	poltrona	20
845	sedia	57
901	sedia	35
902	sedia	34
903	sedia	57
904	sedia	29
905	sedia	30
906	sedia	30
907	sedia	30
908	sedia	37-73
909	sedia	37-73
910	sedia	37
911	sedia	38
912	sedia	38
913	sedia	38
914	sedia	56-63
915	sedia	56
918	sedia	21
921	sedia	27
922	sedia	27
923	sedia	27
926	sedia	28
927	sedia	28
928	sedia	28
930	sedia	32
931	sedia	32
932	sedia	32
933	sedia	32
934	sgabello	60
935	sgabello	60
937	sgabello	60
951	sedia a dondolo	30
952	sedia	27
953	sedia	27
954	sedia	27
955	sedia	32
957	sedia	32
958	sedia	32
959	sgabello	39
960	sgabello	39
961	sgabello	39
964	sedia	57
969	sedia	54
970	sedia	54
971	sedia	54
972	sedia	55
973	sedia	55
974	sedia	55
975	sedia	31
977	sedia	27
978	sedia	27
979	sedia	27
980	sedia	28
981	sedia	28
982	sedia	28

Articolo	Descrizione	Pagina
983	sedia	28
987	sedia	54
988	sedia	54
989	sedia	54
990	sedia	52-61
991	sedia	52-61
992	sedia	52-61
993	sedia	31
995	sedia	60
1001	sedia	59
1002	sedia	59
1007	sedia	59
1022	sedia	59
1688	base per tavolo	70-71
1689	base per tavolo	71
1690	base per tavolo	71
1691	base per tavolo	71
1692	base per tavolo	71
1693	base per tavolo	71
1694	base per tavolo	71-72
1695	base per tavolo	71
1696	base per tavolo	71
1697	base per tavolo	71
1698	base per tavolo	71-72
1699	base per tavolo	71
1700	piano in HPL	73
1701	piano in HPL	73
1702	piano in HPL	73
1703	piano in HPL	73
1704	piano in HPL	73
1705	piano in HPL	73
1706	piano in HPL	73
1707	piano in HPL	73
1708	piano in HPL	73
1709	piano in HPL	73
1710	piano in HPL	73
1711	piano in HPL	73
1712	piano in HPL	73
1713	piano in HPL	73
1714	piano in HPL	73
1715	piano in HPL	73
1716	piano in HPL	73
1717	piano in HPL	73
1718	piano in HPL	73
1719	piano in HPL	73
1720	piano in HPL	73
1721	piano in HPL	73
1722	piano in HPL	73
1723	piano in HPL	73
1724	piano in HPL	73
1725	piano in HPL	73
1726	piano in HPL	73
1727	piano in HPL	73
1728	piano in HPL	73
1729	piano in HPL	73
1730	piano in laminato	71
1731	piano in laminato	71
1732	piano in laminato	71
1733	piano in laminato	71

Articolo	Descrizione	Pagina
1734	piano in laminato	71
1735	piano in laminato	71
1736	piano in laminato	71
1737	piano in laminato	71
1738	piano in laminato	71
1739	piano in laminato	71
1740	piano in laminato	71
1741	piano in laminato	71
1742	piano in laminato	71
1743	piano in laminato	71
1744	piano in laminato	70-71
1745	piano in laminato	71
1746	piano in laminato	71
1747	piano in laminato	71
1753	sedia	57
1755	sedia	23
1841	sedia	48-76-77-78
1842	sedia	48-76-77-78
1868	tavolo allungabile	77
1869	tavolo allungabile	76
1870	tavolo allungabile	77
1871	tavolo allungabile	76
1872	tavolo allungabile	77
1873	tavolo allungabile	76
1892	tavolo autolivellante	62
1893	tavolo autolivellante	62
1894	sedia	49-76-77-78
1895	sedia	49-76-77-78
1900	tavolo allungabile	78
1901	tavolo allungabile	78
1903	tavolo allungabile	78
1904	sedia	56
1905	sedia	56
1914	sedia	7
1915	sedia	22
1921	sedia	34
1922	sedia	34
1923	poltrona	19
1924	poltrona	19
1925	poltrona	22
1926	sedia	3
1929	tavolo allungabile	74-75
1930	tavolo allungabile	74-75
1932	tavolo allungabile	75
1933	tavolo allungabile	75
1936	tavolo allungabile	75
1937	tavolo allungabile	75
1941	sedia	7
1942	sedia	7
1943	sedia	7
1944	sedia	7
1945	sedia	4
1946	sedia	5
1947	sedia	4
1948	sedia	4
1949	sedia	4
1950	sedia	4
1951	sedia	44
1952	sedia	44

Articolo	Descrizione	Pagina
1953	sedia	44
1954	sedia	44
1955	sedia	45-79
1956	sedia	45
1958	sedia	6
1959	sedia	6
1960	sedia	6
1961	sedia	6
1962	sedia	48
1963	sedia	48-67
1964	sedia	48
1965	sedia	48
1966	sedia	48
1967	sedia	48
1968	sedia	5
1972	tavolo allungabile	77
1973	tavolo allungabile	76
1975	tavolo allungabile	78
1976	tavolo allungabile	75
1977	tavolo allungabile	75
1987	tavolo	79
1990	tavolo allungabile	77
1991	tavolo allungabile	76
1992	tavolo allungabile	78
1993	sedia	42
1994	sedia	42
1995	sedia	42
1996	sedia	42-70
2006	sedia	1
2007	sedia	1
2008	sedia	1
2009	set 2 pouf con vassoio	11-15
2010	pouf	14
2011	pouf	14
2012	pouf	14
2013	pouf	14
2014	set 2 pouf	15
2015	pouf	15
2016	pouf	15
2017	pouf	15
2018	pouf	15
2019	sedia con braccioli	8
2020	sedia con braccioli	8
2021	sedia	9
2022	sedia	9
2023	poltrona	10
2024	poltrona	11
2025	sedia	40-62
2026	sedia	40-62
2027	sedia	40-62
2028	sedia	41-62
2029	poltrona e pouf	18
2030	poltrona	18
2031	sedia	2
2032	sedia	2
2033	sedia	2
2034	sedia	2
2035	sedia	1
2036	sedia	1

Articolo	Descrizione	Pagina
2037	sedia	1
2038	sedia	1-66
2039	sedia	46
2040	sedia	46
2041	sedia	46
2042	sedia	46
2043	sedia	46
2044	sedia	46
2045	sedia	43-68-69
2046	poltrona	16
2047	poltrona	16
2048	poltrona	16
2049	poltrona	17
2050	sedia	51
2051	sedia	51
2052	sedia	51
2053	sedia	51
2054	sedia	5
2055	sedia	50
2056	sedia	50
2057	sedia	50
2058	sedia	50
2068	sedia	52-61-65
2069	poltrona	12-13
2070	poltrona	12-13
2071	pouf	12-13-14
2072	pouf	12-13-14
2073	sedia	3
2076	sedia	53
2077	sedia	53
2078	sedia	53
2079	sedia	53
2080	sedia	41-62
2081	sedia	40-62
2082	sedia	40-62
2083	sedia	40-62-65
2096	tavolo	63
2097	tavolo	63
2098	tavolo	63
2099	tavolo	64-65
2100	tavolo	65
2101	tavolo	65
2102	tavolo	61-65-66
2103	tavolo	61-65-66
2104	tavolo	61-65-66
2105	tavolo	67
2106	tavolo	67
2107	tavolo	67
2108	tavolo	68
2109	tavolo	68-69
2110	tavolo	68
2111	tavolo allungabile	75
2112	tavolo allungabile	75
2113	tavolo allungabile	75
2114	tavolo allungabile	75
2115	tavolo allungabile	75
2116	tavolo allungabile	75
2117	tavolo allungabile	75
2118	tavolo allungabile	75
2119	sedia	59



sedie
poltrone
pouf
tavolini bar
tavoli

chairs design
contemporary



Sedie